



XingYue Communication Technology Co., Ltd.

Product Name: Parabolic Antenna

Product Model: XY222504

Electrical Specifications

Frequency Range	4900-5150MHz	5150-5800MHz	5800-6300MHz
Polarization Type	Vertical and Horizontal		
Gain	30±1dBi	31±1dBi	32±1dBi
VSWR	≤1.8:1	≤1.8:1	≤1.8:1
Horizontal Beamwidth	5° ±0.5°	4° ±0.5°	4° ±0.5°
Vertical Beamwidth	5° ±0.5°	4° ±0.5°	4° ±0.5°
Front-to-back Ratio	≥32dB	≥35dB	≥35dB
Isolation Between	≥30		
Input Impedance	50 Ω		
Max Power	50W		

Mechanical Specifications

Connector Type	2*N Female
Dimensions (D*H)	Φ950*185.3mm(37.4*7.3 in)
Radiating Element Material	Aluminum
Reflector Material	Aluminum
Weight	8.5kg
Mounting Pole	Φ40~60 mm
Operating Temperature	-40°C~60°C
Max Wind Velocity	200 km/h



Add:No.11 GuangMing new RD, DongCheng area, DongGuan City, China
Tel: +86 - 769-22333955 Fax: +86 - 769-22000020
E-mail: xingyue@xytx86.com Website: <http://xytx86.com>



XingYue Communication Technology Co., Ltd.

Product Diagram:

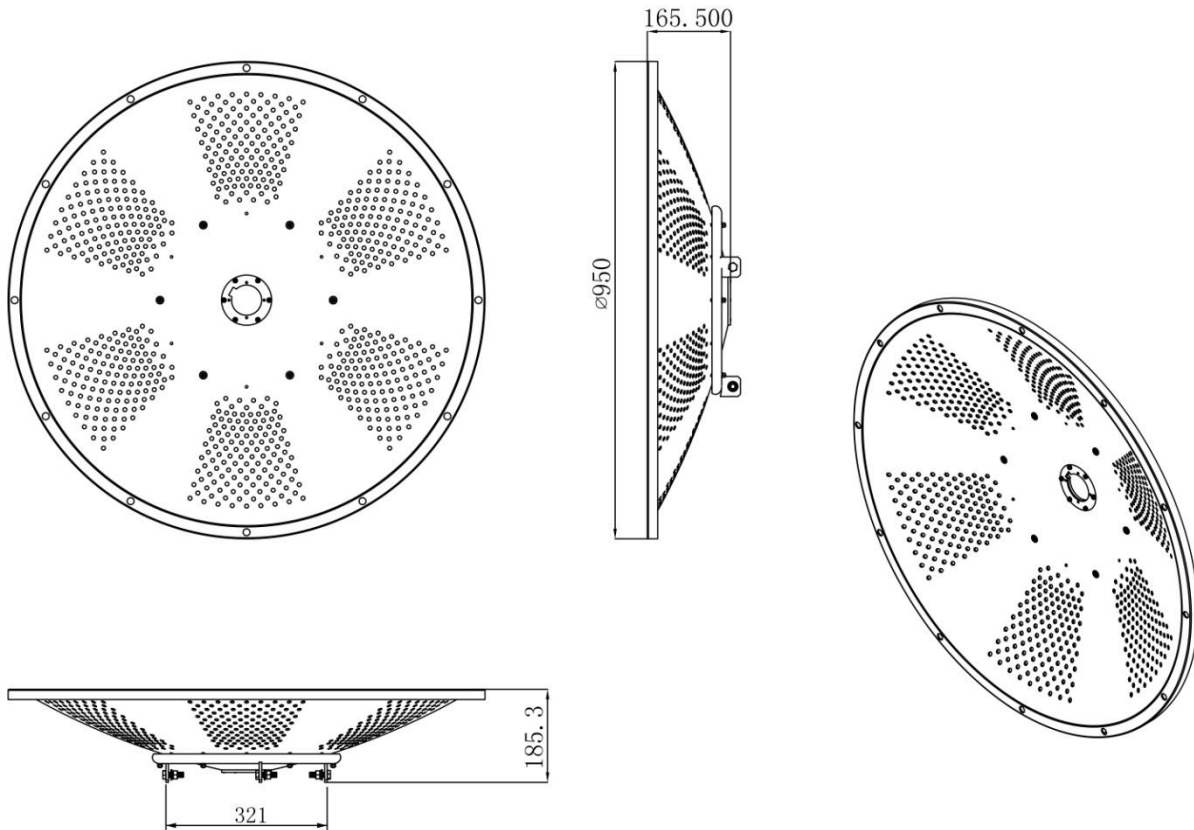

Add: No.11 GuangMing new RD, DongCheng area, DongGuan City, China
Tel: +86 - 769-22333955 Fax: +86 - 769-2200020
E-mail: xingyue@xytx86.com Website: <http://xytx86.com>

Installation Guide:

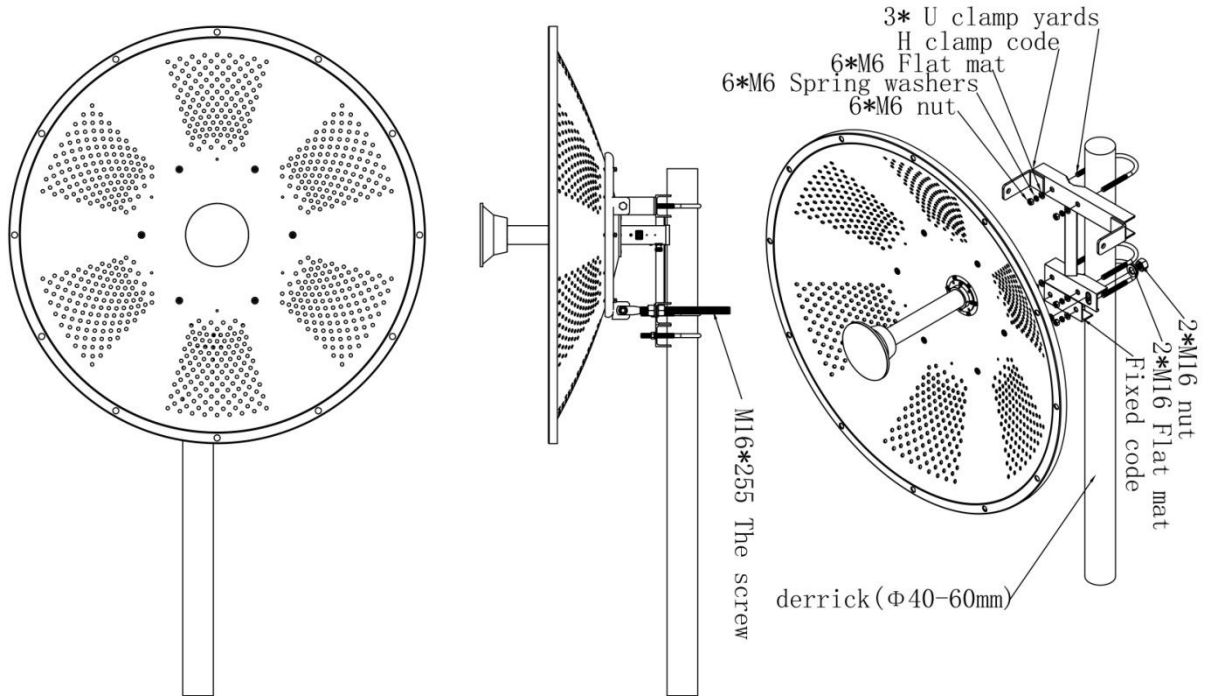

Directional Pattern:

